

C3S EPS Datasheet

Description

C3S EPS-1000 offers a complete solution for the power supply of CubeSats, consisting of 6 independent MPPT channels, an 50Wh battery pack and 12 LCL outputs. Power distribution is made possible on 3 voltage levels (3.3V, 5V, unregulated) The whole subsystem is protected against single-point failure. The EPS-1000 is housed in a robust aluminium case, that guarantees exceptional heat conduction.



Main features

- Recommended for 3U/ 6U and 12U platforms
- Flight heritage acquired in 2021 with the launch of RadCube
- Cold redundancy and graceful degradation
- Single point failure tolerant
- 10 kRAD TID measured during the mission (as October 2022)
- Radiation tested (TID)
- Hardware and Firmware Single Event Upset (SEU) mitigation
- Soldered with leaded tin (Sn63Pb37) on leaded HASL PCB by ESA-qualified hand soldering operators.

Solar panels

- 6 independent MPPT channels
- A total of max. 50W incoming solar panel capacity
- Solar panel characteristics measurement on all 6 channels

Battery pack

- 50 Wh capacity
- Two-level battery undervoltage protection
- Autonomous battery heater and balancer
- At least 6 months shelf time

Power distribution

- 12 independent LCL outputs
- 2 regulated (3.3V @ 4A, 5V @ 4A) and 1 unregulated bus (9.9...12.3 V @ 5A)
- Designed and verified control loop stability
- Overvoltage, overcurrent, overpower and configurable current limitation

Interfaces

- RBF pin, DSW interface
- Telemetry and telecommand communication with redundant CAN bus
- Micro-D main connector (MIL-DTL-83513)
- Nano-D Access Port (battery charging and USB service interface)
- Temperature ranges: circuits: -40°C to 80°C qualified, battery: 0°C to 50°C
- Robust aluminium (T-7070) milling case, outstanding thermal conductivity from dissipators to the structure

C3S EPS-1000 structure

The architecture of the EPS implements the topology of classic serial control. The Solar Arrays are connected to the inputs of the maximum power point tracker (EPS-MPPT), while their cumulative output is connected to the battery (EPS-BAT). Battery charge control is driven by the MPPTs. The voltage of the central unregulated bus is determined by the voltage of the battery. Power is distributed to the avionics and the payload(s) at multiple voltage levels using latching current limiters (LCL 1...12), implemented by the power distribution unit (EPS-PDU). The PDU generates the two regulated voltages (3.3 V and 5 V) from the unregulated bus voltage.

Figure 1: EPS Functional Block Diagram

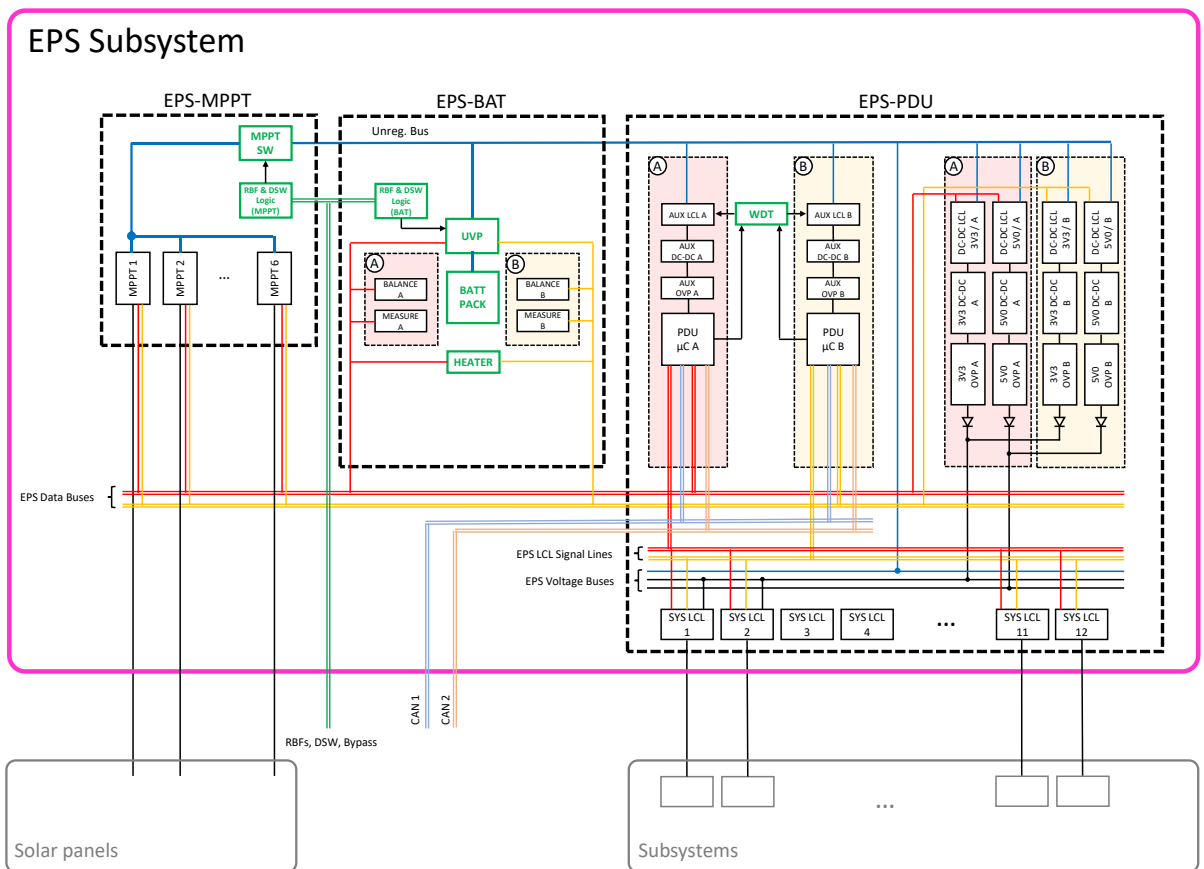
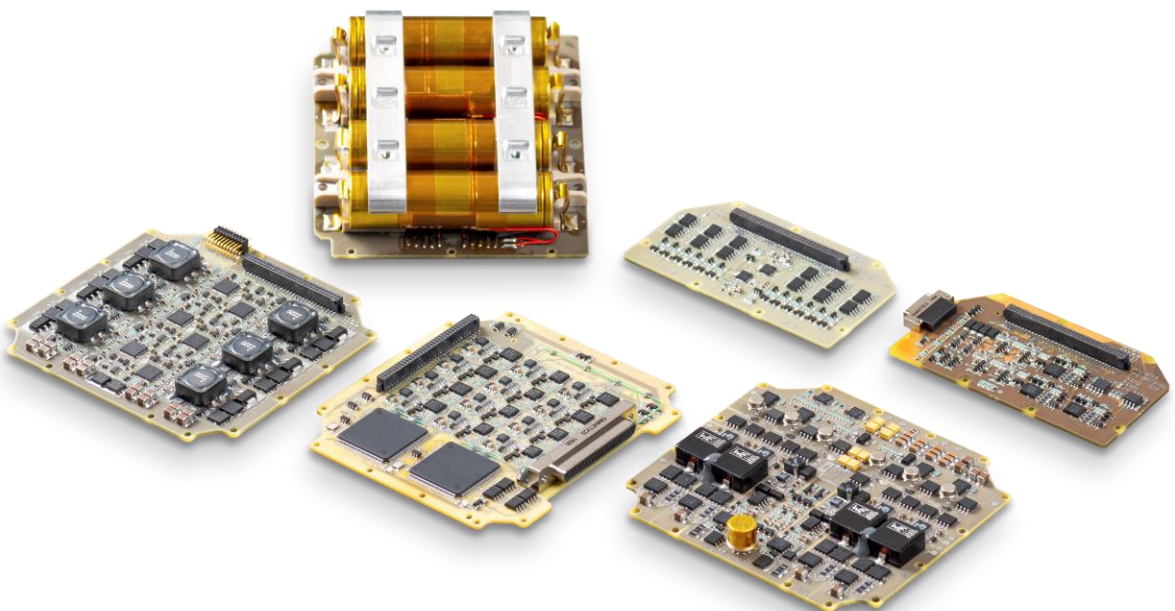
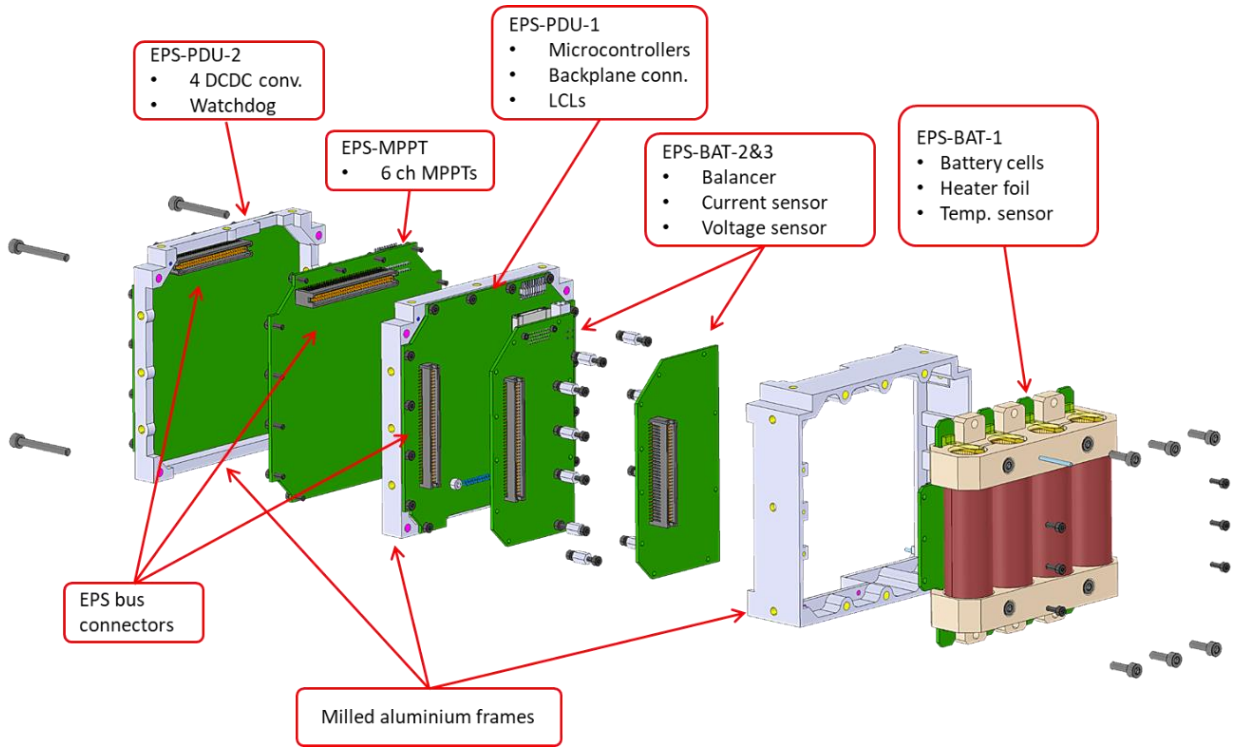

Figure 2: EPS build-up



Detailed operation

MPPT

Block Abbreviations	Block Full Name	Block Functions
MPPT (1...6)	Maximal Power Point Tracker	The purpose of the MPPTs is to interface the solar arrays and the unregulated bus, and to operate the solar arrays at the maximum power point.
MPPT SW	MPPT Switch	The MPPT SW can disconnect the primary energy source from the unregulated bus, if the RBF and DSW do not allow the operation of the satellite.
RBF & DSW Logic (MPPT)	RBF & DSW Logic circuit	A logic circuit that can enable or disable the MPPT SW according to RBF and DSW.

The purpose of the EPS-MPPT is to interface the primary power sources (solar arrays) to the secondary power source (battery) and thereby the central system bus.

6 independent Buck-Boost channels, connecting to the main bus through ideal diodes. All the 6 channels can operate autonomously and can communicate with the PDU uC through the redundant bus.

Channels are designed so that even in case of a single-point failure the battery is not overcharged and there is no over-voltage on the bus.

Telemetry data can be queried, characteristics are taken from the solar panels. The current flowing can be controlled by software, furthermore, search and fix voltage can be selected. In case fix voltage mode, solar panel voltage can be defined, which is set by the solar panel.

BAT

Block Abbreviations	Block Full Name	Block Functions
BALANCE (A/B)	Battery Cell Balancer (cold redundant pair)	Battery charge balancing circuit.
MEASURE (A/B)	Battery voltage, current and temperature measurement (cold redundant pair)	The unit includes the following sensor circuits: Battery cell voltage, battery pack voltage, battery cell balancing current, battery pack current, battery cell temperature.
UVP	Undervoltage protection	Protect battery pack against deep discharge
BAT PACK	Battery Pack	Secondary power source, battery pack.
HEATER	Battery Heater	Heater foils and driver circuits heating the battery cells.
RBF & DSW Logic (BAT)	RBF & DSW Logic circuit	A logic circuit that can enable or disable the UVP circuit according to RBF and DSW. This will ensure that the battery is disconnected from unregulated bus if the RBF and DSW do not allow the satellite to operate.

The secondary power is implemented by six Li-ion battery cells connected in 2P3S configuration. The battery cells are not redundant; however, the protection circuits are single point of failure protected.

The batteries are connected to the unregulated bus via an undervoltage protection circuit (UVP). The UVP circuit has two channels, the normal charge/discharge and the trickle charge channel.

The trickle charge channel is disabled when battery pack voltage is below 8.4V, and is reactivated when it is above 9V. The normal channel is deactivated when battery pack voltage is below 9.9V, and is reactivated when it is above 10.5V. When the normal channel is activated the trickle charge channel can still be active, but no trickle charge current is flowing, as the normal channel shunts the trickle channel.

The cells are sized 18650 and their capacity is 5.4Ah (90% SOC). The cells have autonomy balancing and heating.

Cell-pairs can be heated separately.

PDU

Block Abbreviations	Block Full Name	Block Functions
WDT	Watchdog Timer	Watchdog circuit of the two cold-redundant central PDU microcontrollers. If the active microcontroller fails to reset the watchdog, operation is switched over to the cold-redundant pair.
AUX LCL (A/B)	Auxiliary LCL (cold redundant pair)	The purpose of AUX LCL is to prevent overload of the unregulated power bus in case of a short circuit in the EPS.
AUX DC-DC (A/B)	Auxiliary DC-DC Converter (cold redundant pair)	Auxiliary switched mode power supply generating the internal regulated 3.3V supply voltage of the EPS itself.
AUX OVP (A/B)	Auxiliary Over Voltage Protection (cold redundant pair)	Auxiliary switched mode power supply output overvoltage protection.
PDU μ C (A/B)	EPS-PDU Microcontroller (cold redundant pair)	Microcontroller controlling the complete EPS.
DC-DC LCL 3V3 (A/B) DC-DC LCL 5V0 (A/B)	LCLs of System DC-DC Converters (cold redundant pair)	LCLs are located before the DC-DC converters. Purpose of LCL is to prevent overload of the unregulated bus in case of a short circuit in the DC-DC converter.
3V3 DC-DC (A/B) 5V0 DC-DC (A/B)	System DC-DC Converters	Purpose of DC-DC converter is to generate regulated bus voltage for on-board systems.
OVP DC-DC 3V3 (A/B) & OVP DC-DC 5V0 (A/B)	Over Voltage protections (cold redundant pair)	3.3V & 5.0V system DC-DC converters' output overvoltage protection.
SYS LCL	Subsystem LCL	LCL circuits of on-board subsystems.
EPS Data Buses	EPS Data Buses	EPS internal data bus connecting internal EPS circuits to the central microcontroller (PDU PDU μ C A/B).
EPS Voltage Busses	EPS Voltage Busses	EPS internal regulated and unregulated voltage busses.

Energy distribution is made possible on three voltage levels (unregulated, 3V3, 5V). Regulated buses are generated by redundant DC-DC converters. Regulated buses have overcurrent and undercurrent protection. The 12 outputs can be switched through Limiter Switches (LCL).

Implementation of redundancy

The EPS features redundant architecture; however, the exact implementation of redundancy differs between its units:

Unit:	EPS-MPPT
Redundancy type:	Graceful Degradation (GD)
Description	<p>The 6 independent channels are connected to the unregulated bus through ideal diodes, so in case of the failure of any of the channels, only the defective channel's performance is lost.</p> <p>The outputs of the MPPT channels are protected against overvoltage, so the unregulated bus is protected against overvoltage even in case of single point failure</p>
Single point failure	<ul style="list-style-type: none"> • The battery cannot be overcharged. • Incoming power from solar arrays does not fail completely, only graceful degradation occurs, in worst-case the power from one MPPT channel is lost (out of six MPPT channels in total)
Unit:	EPS-BAT
Redundancy type:	Cold Redundancy (CR) / Graceful Degradation (GD)
Description	<p>All service electronics, like the telemetry collector, has under voltage lockout, while the heater and balancer circuits are redundant or in case of single point failure, their safety condition is guaranteed.</p>
Single point failure	<p>In case of the battery pack (BAT PACK):</p> <ul style="list-style-type: none"> • Open circuit of a single battery cell: battery pack capacity is decreased. • Short circuit of a single battery cell: The undervoltage protection disconnects the battery pack from the unregulated bus. The satellite is still capable of operation on the illuminated sections of the orbit
Unit:	EPS-PDU
Redundancy type:	Cold Redundancy (CR)
Description	<p>The modules generating the regulated bus voltages has an A and a B redundancy pair. A dedicated A and B PDU uC belongs to the A and B sides. In case there is either a hardware or software failure on the active side, a single-point failure tolerant control block will perform the switch to the redundant pair.</p> <p>All LCLs (SYS LCL 1...12) can be controlled by both microcontrollers.</p>
Single point failure	<ul style="list-style-type: none"> • Switch to the redundant pair (except when the failure happens in the control electronics, in such case there's no switching to avoid unwanted oscillation) • The LCLs are not redundant, but they can be switched off even in case of single-point failure

General performance

Property	Value/Options	Notes
Maximum Input Solar Arrays Power	46.9 W	
Maximum Output Power	90 W	
Standby current quiescent per battery cells	Max. 250 μ A	On the shelf
	Max. 150 μ A	In POD
Communication	Redundant CAN	
Type of The Redundancy	Cold Redundancy and Graceful Degradation	
Communication	CAN A CAN B	Redundant line
Dimension		
X	88.5 mm	Measured on EQM
Y	96 mm	Measured on EQM
Z	88.1 mm	Measured on EQM
Mass	811 g	Measured on EQM
Maximum Operating Temperature	+80 $^{\circ}$ C	Except battery pack
Minimum Operating Temperature	-40 $^{\circ}$ C	Except battery pack

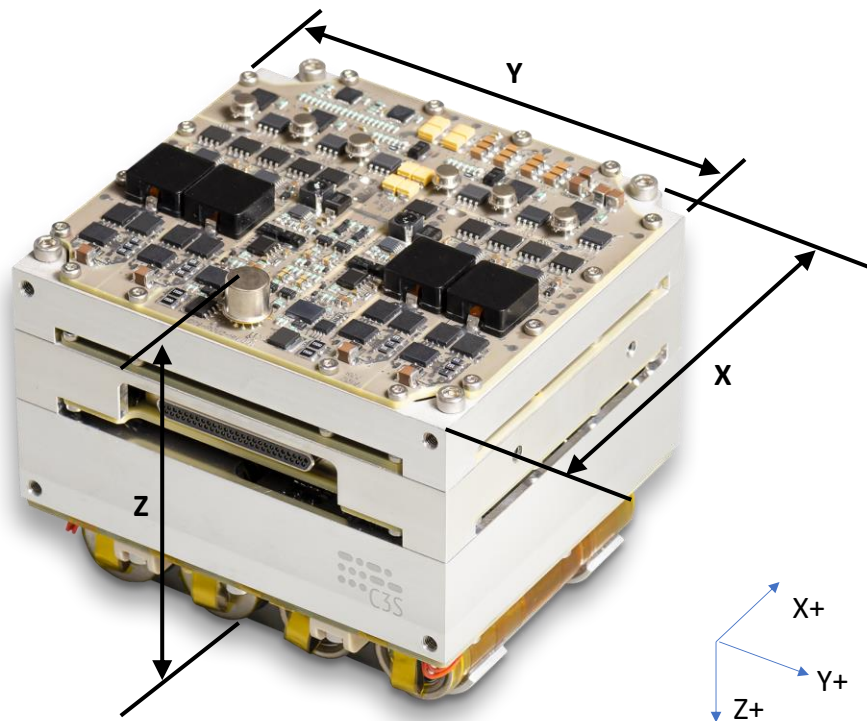

MPPT unit specification

Property	Value/Options	Notes
EPS-MPPT PANEL		
Preferred Solar cell type	Si and Triple Junction	For example: CESI CTJ30 (26.5cm ²)
Maximum Total Input Power	46.9 W	
Maximum Output Current	5 A	
Maximum Operating Temperature	+80 °C	
Minimum Operating Temperature	-40 °C	
Maximum Total Input Power	46.9 W	
Number of MPPT channels	6	
ALL CHANNELS		
Maximum Input Power per Channels	12.9 W	
Maximal Number of Series Solar Cells	7	Triple Junction Solar
Minimal Number of Series Solar Cells	3	
Programmable Solar Cell Voltage	6...25 V	min. 3 and max. 7 series Triple-Junction Solar Cells MPPT AUX power supply minimum operation input voltage 5.5V, PWM converter's UVLO is 6V
Nominal Output Voltage	9.9...12.3 V	3 series Li-ion Battery cells
Maximum Output Voltage	12.6 V	Maximum possible voltage in case of single point failure.
Maximum Output Surge Voltage	13.5 V	Transient
Maximum Surge Voltage Time	10ms	Transient
Maximum Input Current	0.75 A	
Maximum Output Current	1.2 A	
Minimal efficiency	~65 %	T = 25°C, U _{out} = 12.3V, P _{in} = 1.0W
Maximal efficiency	~89 %	T = 25°C, U _{out} = 12.3V, P _{in} = 11W
Switching frequency	400...480 kHz	Nominal: 440 kHz
Control mode	Current mode	
Tracking frequency	100 Hz	
Power transmission circuit wake-up time	150 ms	
Start of search after activation	1 sec	Before the MPP search starts the MPPTs use a pre-set operating point for the solar arrays.

Efficiency

Figure 3: One channel EPS-MPPT efficiency, battery voltage is 12.3V

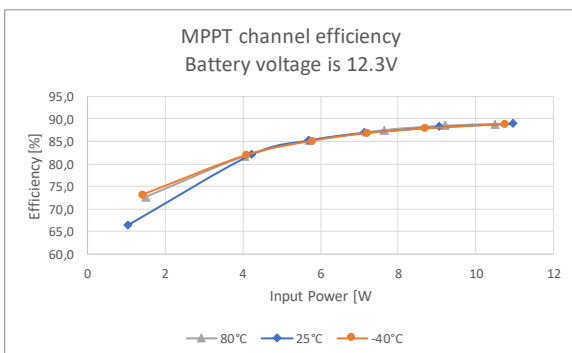
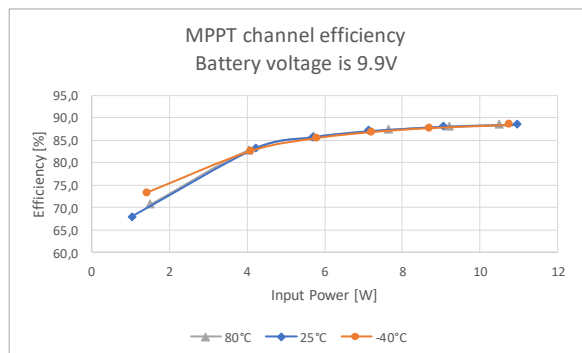

Figure 4: One channel EPS-MPPT efficiency, battery voltage is 9.9V



EPS-BAT unit specification

Property	Value/Options	Notes
Battery chemistry	Li-ion	
Battery cell type	LG INR18650HG2	
Battery Pack Configuration	2P3S	6pcs. cells
Battery pack voltage range	9.9 V ... 12.3 V	Between 9.9 V and 8.4 V battery is trickle charged.
UVP Normal low threshold	9.9 V	
UVP Normal high threshold	10.5 V	
UVP Trickle low threshold	8.4 V	
UVP Trickle high threshold	9 V	
Nominal Pack Capacity	5.4 Ah	90% SOC.
Nominal Pack Stored Energy	58.3Wh	Assuming 3.6V average voltage of battery cells and 90% SOC.
Minimal stored usable energy before launch	20 Wh	Battery discharged from 11.1V to 9.9V. This is the worst-case minimal energy left after 6months storage before launch.
Maximum Pack Charge Current	5 A	Current measurement is designed based on this value, cells and UVP normal channel can handle more.
Maximum Pack Discharge Current	5 A	Current measurement is designed based on this value, cells and UVP normal channel can handle more.
Heater	YES	One heater foil per battery cell.
Balancer	Passive	
Max cell balancer current	50 mA	4.2 V battery cell voltage
Max trickle charge current	100 mA	12.3 V Unreg Bus, 8.4 V battery pack voltage
Maximum heater power	5.4 W	Total heater power of all six heater foils. Autonomous heater control per cell pairs.
Heater LCL nominal current	120 mA	9.9 V Unreg Bus, -40 °C
	150 mA	12.3 V Unreg Bus, 80 °C
Heater LCL current limit	270 mA	9.9 V Unreg Bus, 80 °C
	410 mA	12.3 V Unreg Bus, -40 °C
Battery protection electronics operating temperature range	-40°C ... 85°C	
Battery cell operating temperature range	-20°C ... 75°C	During discharge, based on datasheet values.
	0°C ... 50°C	During charge, based on datasheet values.
EGSE OT comparator high threshold	50 °C	OT signal is active when a battery cell temperature is above 50 °C.
EGSE OT comparator low threshold	45 °C	OT signal is deactivated after all battery cell temperatures go below 45 °C.

EPS-PDU unit specifications

Property	Value/Options	Notes
Number of System LCL channels	12	
@3.3V	6	It can be configured during manufacturing (0...12)
@5.0V	4	It can be configured during manufacturing (0...12)
@ Unregulated Bus	2	It can be configured during manufacturing (0...12)
Nominal Voltage Levels		
3V3 Regulated Output Voltage	3.20 V ... 3.45 V	Nominal: 3.40 V
5V0 Regulated Output Voltage	4.90 V ... 5.40 V	Nominal: 5.20 V
Unregulated Bus Output voltage	9.9 V ... 12.6 V	Nominal: 9.9...12.3 V
Maximum LCLs Output Current		
@3.3V	4 A	
@5.0V	4 A	
@ Unregulated Bus	5 A	
Duration of switching to Redundant pair	min.: 1.6 s (EOL) max.: 2.4 s (BOL)	EPS WDT switching time
5V0 DC-DC converter specifications		
Input voltage range	8 V...14 V	The operating voltage range of the converter IC is 7.5V... 60V.
Nominal output voltage	5.1 V	
Output voltage range	4.90 V...5.40 V	Nominal: 5.2V
Maximum Output Current	4 A	
Minimal Efficiency	85 %	$I_{out} = 0.5 \text{ A.}$
Maximal efficiency	93 %	$I_{out} = 4.0 \text{ A.}$
Switching frequency	400 kHz	Nominal
Control mode	Current mode	
3V3 DC-DC converter specifications		
Input voltage range	8 V...14 V	The operating voltage range of the converter IC is 7.5V... 60V.
Nominal output voltage	3.40 V	
Output voltage range	3.20 V...3.45 V	Nominal: 3.4V
Maximum Output Current	4 A	
Minimal Efficiency	78 %	$I_{out} = 0.5 \text{ A.}$
Maximal efficiency	90 %	$I_{out} = 4.0 \text{ A.}$
Switching frequency	400 kHz	Nominal
Control mode	Current mode	

DC-DC efficiency

Figure 5: 3V3 DC/DC A efficiency curve

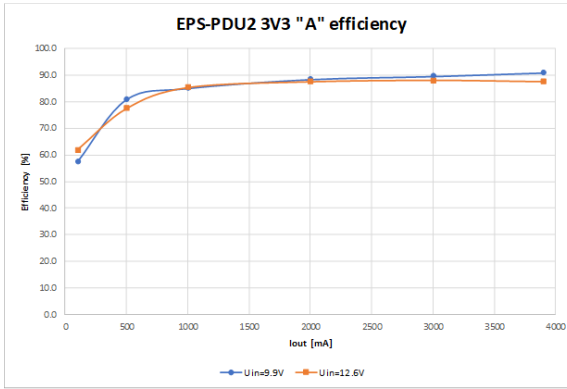

Figure 6: 3V3 DC/DC B efficiency curve

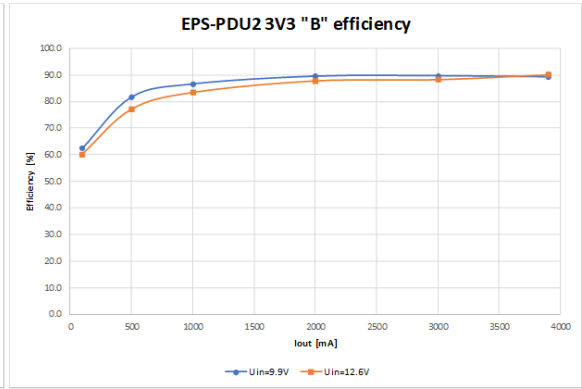

Figure 7: 5V0 DC/DC A efficiency curve

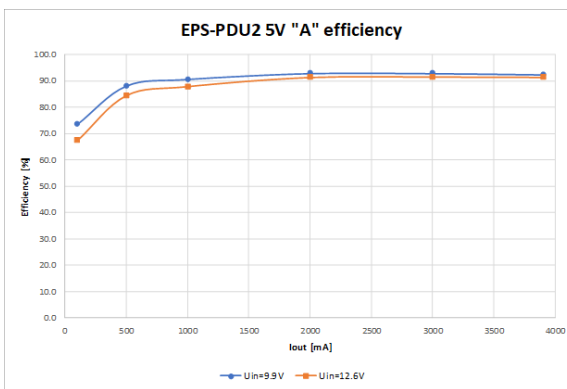

Figure 8: 5V0 DC/DC B efficiency curve

