

Completed as a **multi-output low-noise SMPS** for the PLATO satellite in cooperation with ESA. Only a BreadBoard was completed from this module.

Both converters are implemented using a galvanically isolated converters with common CM+DM Filters on the input.

As requirements changed drastically during the project (power rose by a factor of 3), two versions were breadboarded from both of these converters:

- One with Flyback architectures (lower power)
- One with Forward architectures (higher power)

The SMPS' have operating frequencies of:

- 250 kHz (synchronized)
- 220 kHz (free-running)

The PSU also features synchronized magnetic feedback with a synchronized frequency of 5 MHz and a free-running frequency of 4.3 MHz.

**Compliance with standards:**

- Derating: **ECSS-Q-ST-30-11C**
- CE of CM and DM Noise, Inrush current: **ECSS-E-ST-20-07C** (*Sub-system and equipment limits*)
  - PLATO requirements were actually much stricter, than standard ECSS ratings

**Temperature range:** [-40°C, +60°C]

**FM radiation level:** TID: 50 krad

**Input protections**

- Under-voltage Lockout
- Optional input LCL (Overcurrent protection)

**Optional output features**

- Overcurrent and overvoltage protection
- Off-the-shelf and custom LDO
- DM and CM filter

**Design versions:**

The simplest design features no HK data collection, and only basic overcurrent protection for the outputs.

*Optional HK data:*

- Overcurrent and overvoltage signals from output channels
- Input UVLO signal
- "Voltage good" signals (window comparators on all outputs)
- Temperature (AD590MF sensor)

These data and the circuit protection can be handled with a custom HK&DAQ block made of discrete digital components - Data decoding and provision to a unique digital bus

**Figure 1: BB and measurement setup of the customizable PSU**

**Table 1: Input parameters**

Implemented minimum voltage	Implemented nominal voltage	Implemented maximum voltage	Customizable minimum voltage	Customizable maximum voltage
26V	28 V	29V	10V	400V

*Note 1: The narrower the input voltage range, the more efficient the converter can be. The maximal input voltage range of max/min is that is doable is 3 with a flyback, and 2 with the forward architecture.*

*Note 2: There are sharp rises in mass and volume where there needs to be a switch between capacitor voltage ratings (60V, 120V, 300V, as ECSS deratings must apply).*

**Table 2: Output parametes (First version, Flyback architectures)**

Channel	Implemented parameters				Customizable parameters		
	Minimal voltage	Maximum voltage	Maximal current	DM noise and ripple (pk-pk)	Minimum voltage	Maximum voltage	Maximum current
V_CCD	32.2V	32.6V	150mA	10mV	3.3V	100V	
V_AN1	6.2V	6.5V	300mA	10mV	3.3V	100V	
V_AN2	3.7V	4V	300mA	10mV	3.3V	100V	
V_AN3	-6.5V	-6.2V	300mA	10mV	3.3V	100V	
V_CLK	12.2V	12.5V	300mA	10mV	3.3V	100V	
V_DIG	3.9V	4.15V	1500mA	10mV	3.3V	100V	

**Table 3: Output parametes (Second version, Forward architectures)**

Channel	Implemented parameters				Customizable parameters		
	Minimal voltage	Maximum voltage	Maximal current	DM noise and ripple (pk-pk)	Minimum voltage	Maximum voltage	Maximum current
V_CCD	32.2V	32.6V	412mA	10mV	3.3V	100V	
V_AN1	6.2V	6.5V	591mA	10mV	3.3V	100V	
V_AN2	3.7V	4V	1579mA	10mV	3.3V	100V	
V_AN3	-6.5V	-6.2V	-169mA	10mV	3.3V	100V	
V_CLK	12.2V	12.5V	1212mA	10mV	3.3V	100V	
V_DIG	3.9V	4.15V	3130mA	10mV	3.3V	100V	

**Figure 2: Block diagram of the customizable PSU**

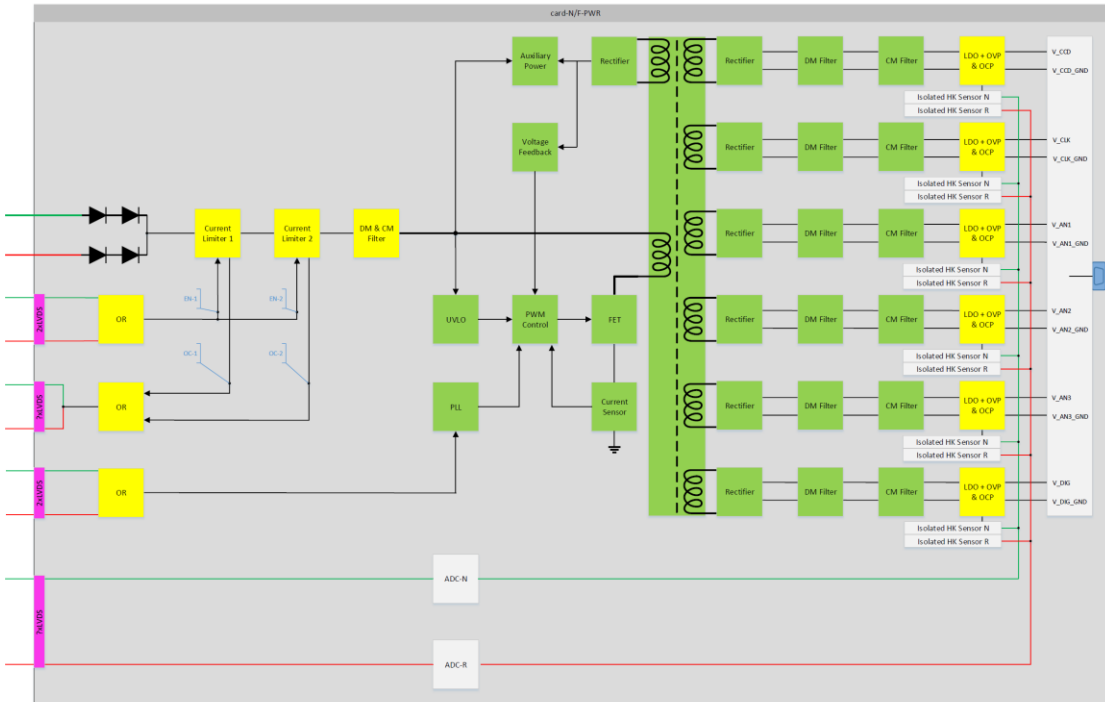

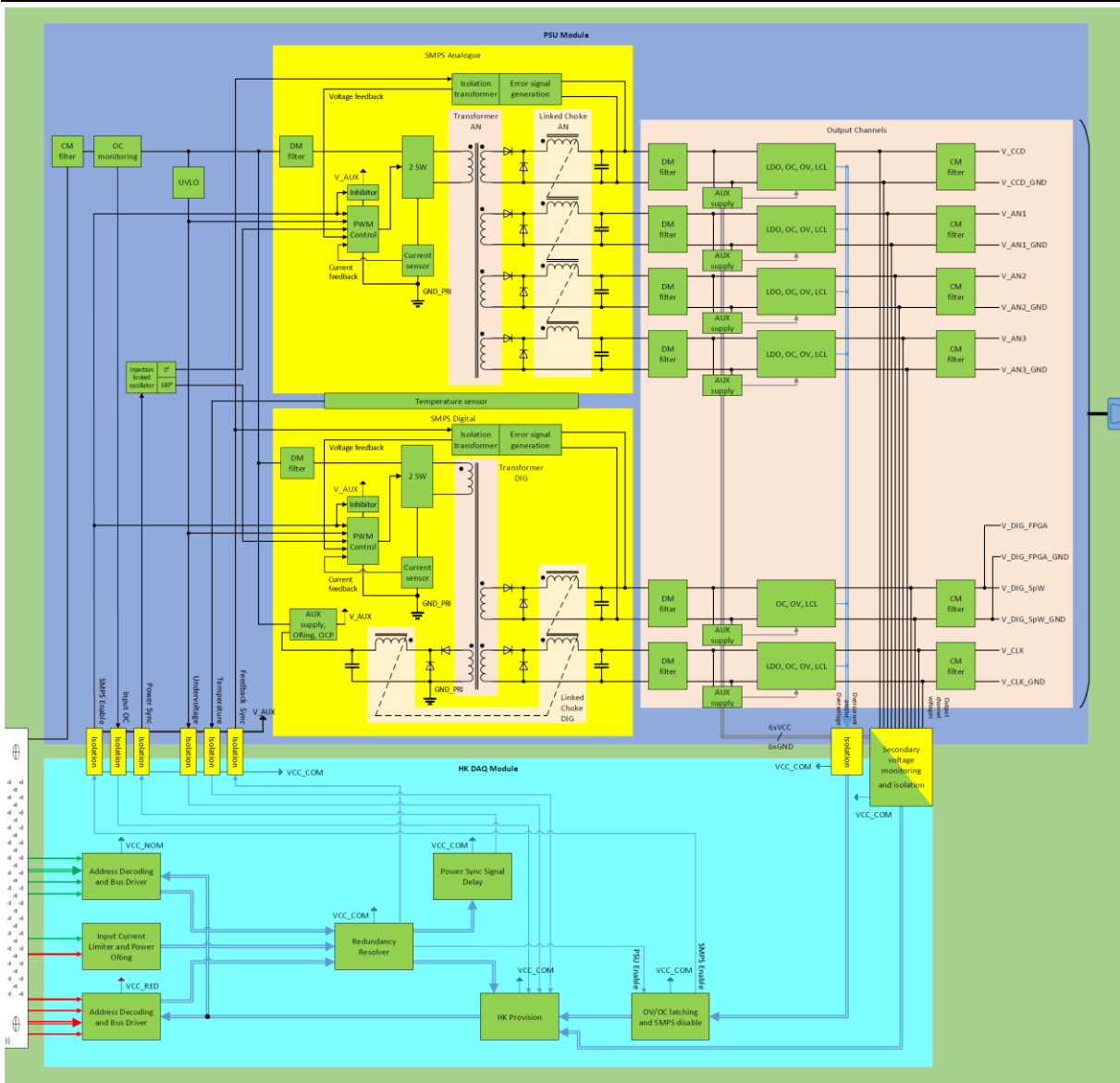

N-AEU-Flyback BB

N-AEU measurement (Flyback + custom LDO)

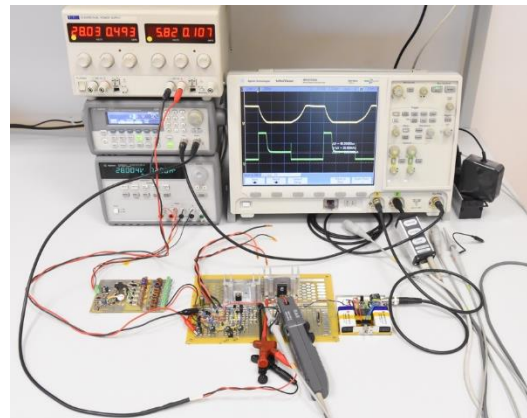
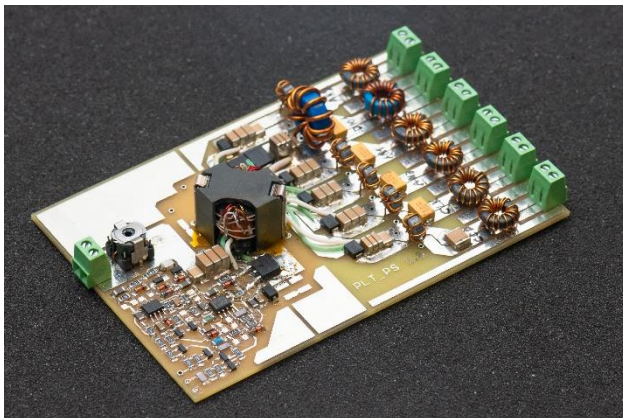

### F-AEU-Coupled Choke Forward BB

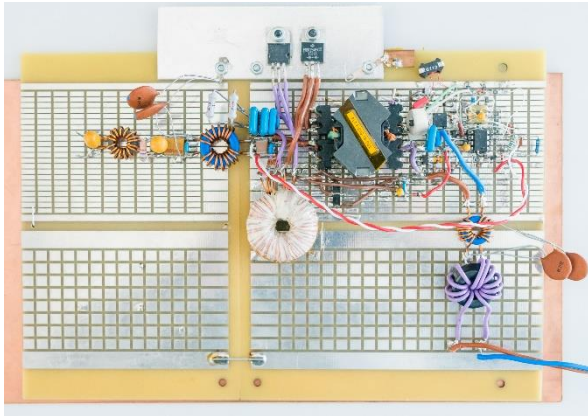

### F-AEU measurement

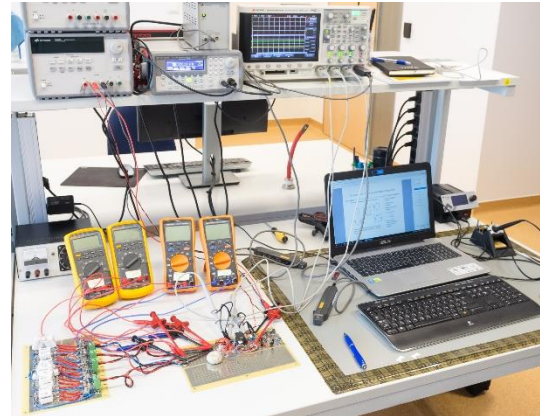

### HK&DAQ Control card

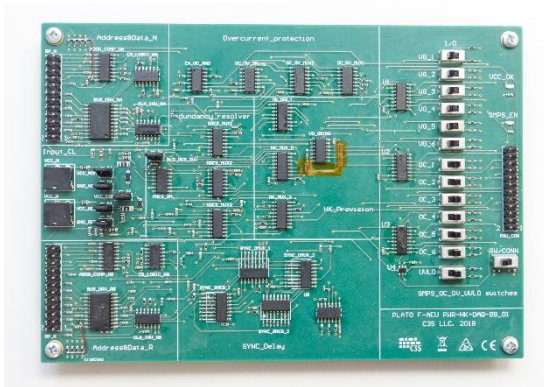

### FPGA+HK&DAQ Control measurement



### Power card plan - rendered image



### N-AEU + F-AEU pan - rendered image

